

## Semiconductor Type Pressure Switches

These pressure switches have built-in electronic circuit on a semiconductor pressure sensor and an open collector insulated by a photocoupler has been used as output. As the use of semiconductor has put movable parts away from the sensor section, high reliability and durability can be obtained.

These pressure switches are suitable for the applications not only compact, light weight and vibration-proof are required but also better substitute to conventional pressure switches.

### Model Number Designation

J	T	-02	-100	-11
Series Number	Type of Mounting	Valve Size	Max. Setting Pressure MPa (PSI)	Design Number
<b>J:</b> Semiconductor Type Pressure Switch	<b>T:</b> Threaded Connection	<b>02</b>	<b>35:</b> 3.5 (510) <b>100:</b> 10 (1450) <b>200:</b> 20 (2900) <b>350:</b> 35 (5080)	<b>11</b>

### Specifications

Model Numbers		JT-02 -35-11	JT-02 -100-11	JT-02 -200-11	JT-02 -350-11
Description					
Max. Operating Pressure	MPa (PSI)	10 (1450)	10 (1450)	20 (2900)	35 (5080)
Proof Pressure	MPa (PSI)	20 (2900)	20 (2900)	40 (5800)	50 (7250)
Pressure Setting Range	MPa (PSI)	0.1 – 3.5 (15 – 510)	1 – 10 (145 – 1450)	2 – 20 (290 – 2900)	3.5 – 35 (510 – 5080)
Pressure Setting (ON pressure Setting)		Single adjustment: ON trimmer setting (variable resistor)*			
Differential Pressure Setting (OFF Pressure Setting)		Single adjustment: DIFF trimmer setting (-1 to -10% of the ON pressure setting)			
Sign on act		When the ON pressure, the LED indicator lights.			
Output System		Open collector (photocoupler insulated) Maximum operating voltage : 35 VDC; maximum current: 100 mA			
Power Source		10 to 28 VDC (ripple included). A constant-voltage power supply must be used. Current consumption: 10 mA.			
Insulation Resistance		100 MΩ or more			
Response Time		1.5 ms	20 ms (damper contained)		
Repeatability		Approx. 0.5 %			
Operating Temperature Range		-20 to +70 °C (-4 to 158 °F)			
Setting Fluctuation with Temperature Drift		1% or less of the maximum operating pressure relative to 10 °C change.			
Storage Temperature Range		-40 to +105 °C (-40 to 221 °F)			
Dust-proofness /Water-Proofness		IEC Pub. 529 IP54			
Vibration-resistance		98 m/s <sup>2</sup> (322 ft./s <sup>2</sup> ) (10 – 55 Hz)			
Shock-resistance		98 m/s <sup>2</sup> (322 ft./s <sup>2</sup> )			
Mass		17g (.39 lbs.)			

★ Trimmer Rotation Angle: 0 to 260°

### Instructions

Voltage-proof test should not be carried out as semiconductor has been used.

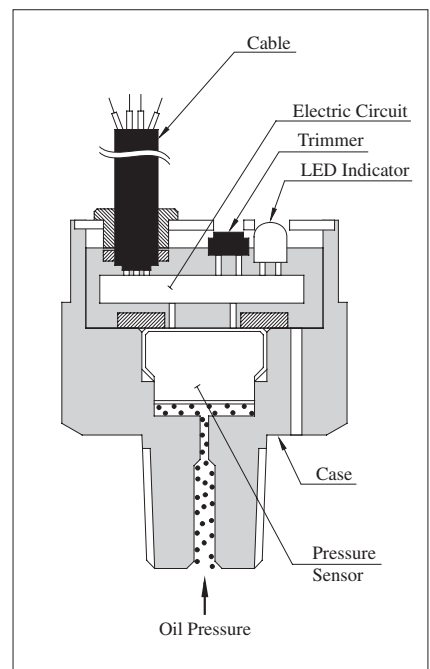

Graphic Symbol



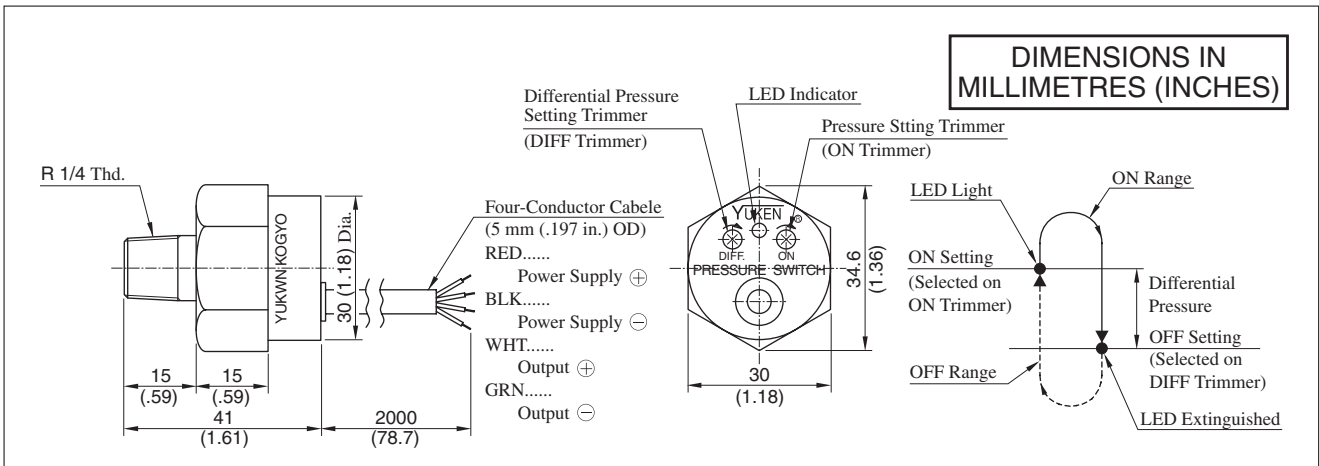

## Adjustment

- Before starting, turn the ON and DIFF trimmers fully clockwise. (Trimmer Rotation Angle: 0 – 260°)
- Turn on the power.
- < ON pressure setting >  
Apply required pressure to the switch. Turn ON trimmer slowly anti-clockwise and stop it when LED indicator lights, ON setting obtained.
- < Differential pressure setting >  
Gradually reduce pressure to obtain the required OFF pressure. Then, turn DIFF trimmer anti-clockwise slowly and stop it when LED indicator goes off. The OFF setting is now obtained.
- Make sure if "ON" or "OFF" setting is correct by working of LED indicator when applying or reducing pressure repeatedly several times.

## Application Examples of Electrical Circuit

### Output Circuit of Semiconductor Type Pressure Switch (Internal Circuit)

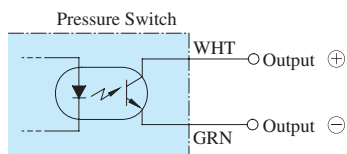

### Direct Relay Drive

- Use relay operable at 100 mA or lower.
- Connect surge voltage absorption diode (D) in parallel with the relay coil.
- Connect protective diode (D) between the white and green wires.

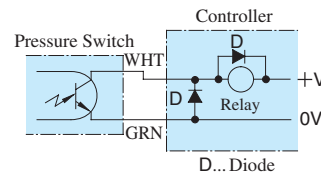

### Connection to Sequential Controller

#### 1. Sink System

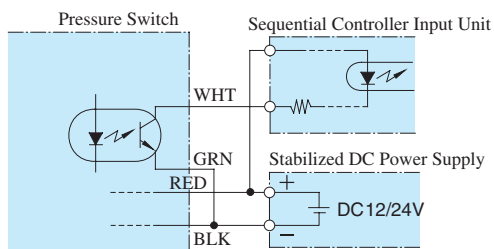

#### 2. Source System

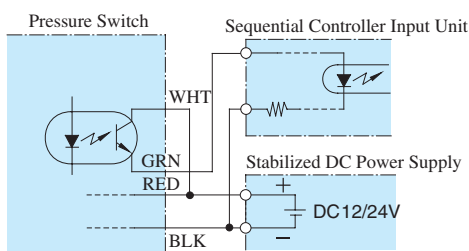

### The usage below is possible because output circuit is insulated by a photocoupler.

#### 1. When AND circuit Two Pressures

The sequential controller is signaled only when pressure switches No. 1 and 2 are both ON.

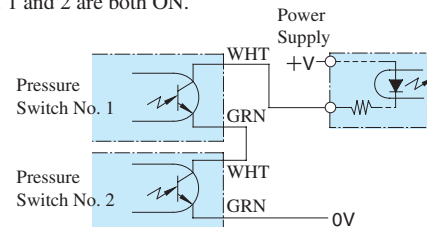

#### 2. When OR circuit two pressures

The sequential controller is signaled when either of pressure switches No. 1 and 2 is ON.

