

Throttle and Check Modular Valves

Specifications

Model Numbers	Max. Operating Pressure MPa (PSI)	Max. Flow L/min (U.S.GPM)
MSA-01-**-50 MSB-01-**-50 MSW-01-**-50	31.5 (4570)	60 (15.9) *

* At the low differential pressure, maximum flow is limited. See "Pressure Drop at Throttle Fully Open" of the next page.

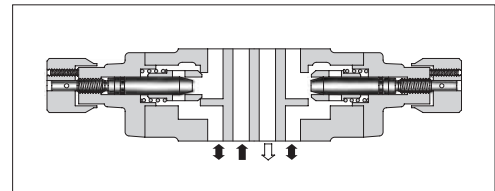

Model Number Designation

F-	MSW	-01	-X	Y	-50	*
Special Seals	Series Number	Valve Size	Direction of Flow ("A" Line)	Direction of Flow ("B" Line)	Design Number	Design Standard
F: Special Seals for Phosphate Ester Type Fluids (Omit if not required)	MSA : Throttle and Check Valve for A-Line	01	X : Metre-out Y : Metre-in	—	50	Refer to *
	MSB : Throttle and Check Valve for B-Line		—	X : Metre-out Y : Metre-in		
	MSW : Throttle and Check Valve for A&B-Lines		X : Metre-out Y : Metre-in	Y : Metre-in		
			Y : Metre-in	X : Metre-out		

* Design Standards: None Japanese Standard "JIS", European Design Standard and N. American Design Standard

Instructions

- To make flow rate adjustment, loosen locking screw for the dial and turn the flow adjustment dial clockwise or anti-clockwise. For a decrease of flow, turn the dial clockwise. Be sure to re-tighten the locking screw firmly after the adjustment of the flow rate.

Graphic Symbols

Metre-out	Metre-in
 MSA-01-X	 MSA-01-Y
 MSB-01-X	 MSB-01-Y
 MSW-01-X	 MSW-01-Y
Metre-out · Metre-in	Metre-in · Metre-out
 MSW-01-XY	 MSW-01-YX

Typical Performance Characteristics

Hydraulic Fluid: Viscosity 35 mm²/s (164 SSU), Specific Gravity 0.850

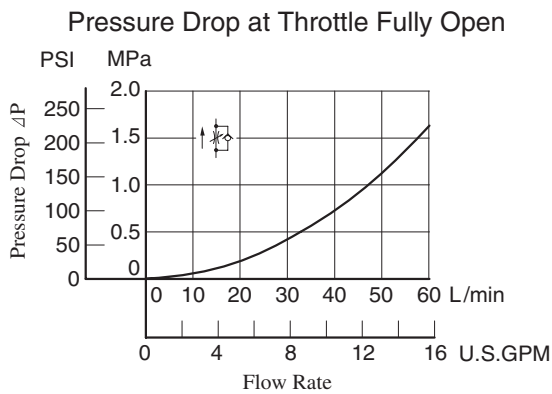
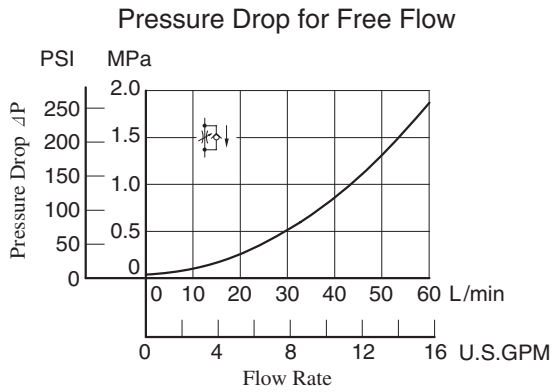
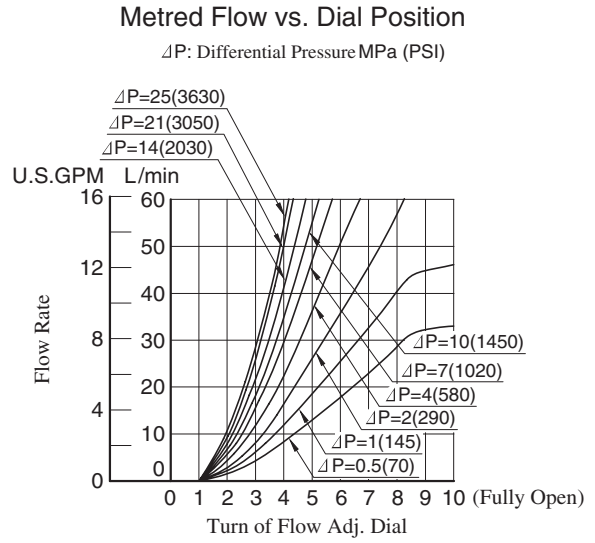
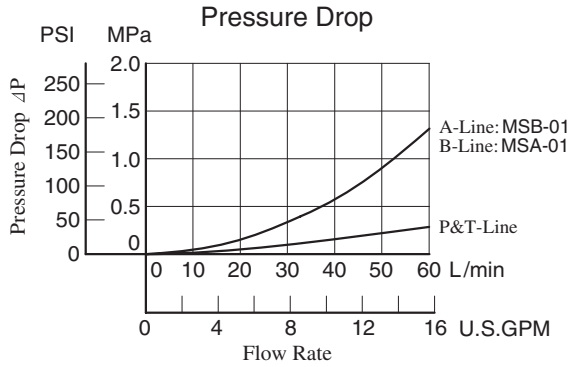

Application

Circuit of Clamp Cylinder for Injection Molding Machine

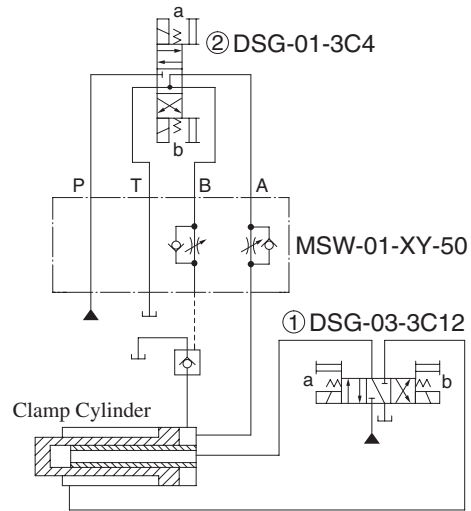

Operation Sequence

Clamp Cylinder	Advance	End Point Pressurisation	Decompression	Retreat
Solenoid Operated Directional Valve ①	Sol.a ON	→	Centre Position	Sol.b ON
Solenoid Operated Directional Valve ②	Sol.b ON	Sol.a ON	Sol.b ON	→

MSW-01-X_Y-50

DIMENSIONS IN MILLIMETRES (INCHES)

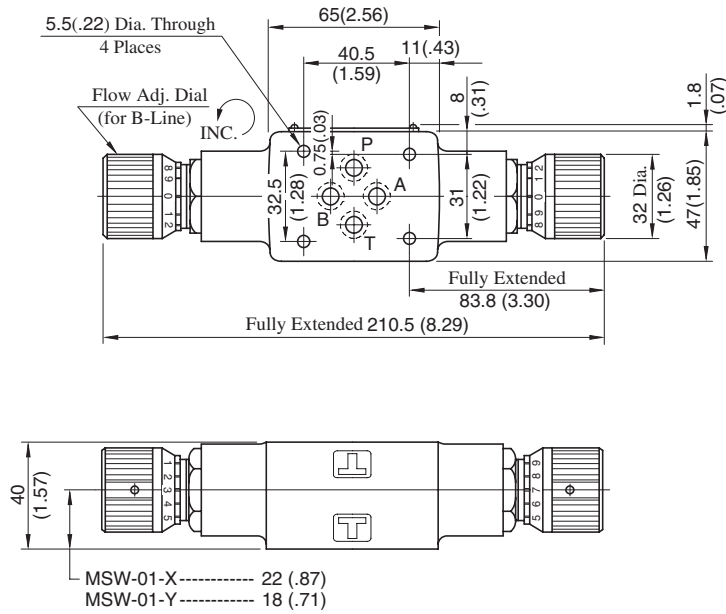

Approx. Mass..... 1.5 kg (3.3 lbs.)

MSW-01-XY_{YX}-50

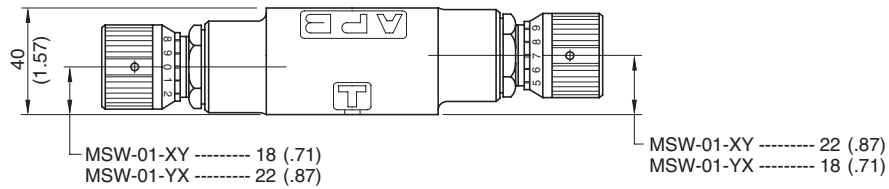

Approx. Mass..... 1.5 kg (3.3 lbs.)

• For other dimensions, refer to "MSW-01-X_Y" drawing above.

MSA-01-X_Y-50

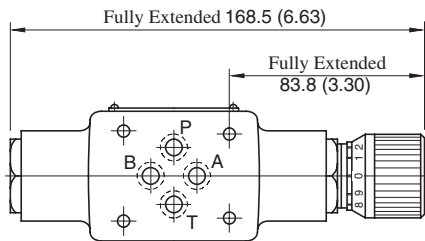

Approx. Mass..... 1.3 kg (2.9 lbs.)

MSB-01-X_Y-50

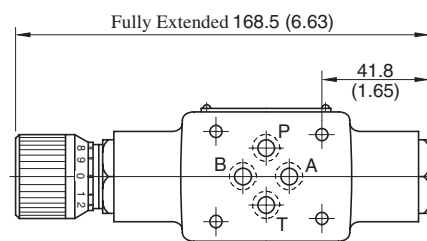

Approx. Mass..... 1.3 kg (2.9 lbs.)

• For other dimensions, refer to "MSW-01" drawing above.

■ Spare Parts List

MSA-01-X-Y-50

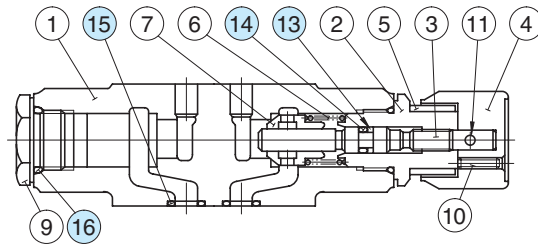

MSB-01-X-Y-50

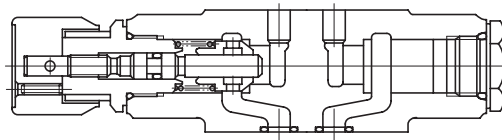

MSW-01-**-50

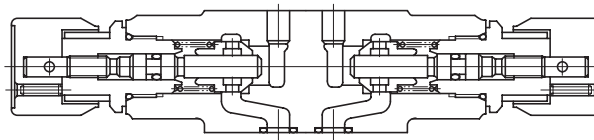

● List of Seals

Item	Name of Parts	Part Numbers	Quantity	
			MSA,MSB	MSW
13	Back Up Ring	SO-BB-P6	1	2
14	O-Ring	SO-NA-P6	1	2
15	O-Ring	SO-NB-P9	4	4
16	O-Ring	SO-NB-P18	2	2

Note: When ordering seals, please specify the seal kit number from the table right.

● List of Seal Kits

Valve Model Numbers	Seal Kit Numbers
MSA-01	KS-MSA-01-30
MSB-01	
MSW-01	KS-MSW-01-30